

Thermistor motor protection relay

CM-MSS.11

The thermistor motor protection relay CM-MSS.11 monitors the winding temperature of motors and protects them from overheating, overload and insufficient cooling.

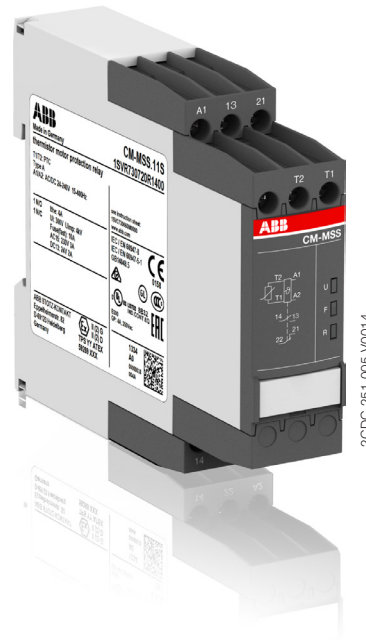





The device is available with two different terminal versions. You can choose between the proven screw connection technology (double-chamber cage connection terminals) and the completely tool-free Easy Connect Technology (push-in terminals).



Characteristics

- 1 measuring circuit
- Automatic reset
- Dynamic interrupted wire detection
- Non-volatile fault storage
- LEDs to distinguish between different failure causes
- Overvoltage protected supply and measuring inputs
- Increased interference immunity acc. to EN 62061 with evaluation criterion "Fail-Safe"
- According to the latest version of the product standard IEC 60947-8
- Screw connection technology or Easy Connect Technology available
- Housing material for highest fire protection classification UL 94 V-0
- Tool-free mounting on DIN rail as well as demounting
- 22.5 mm (0.89 in) width

Approvals

-  UL 508, CAN/CSA C22.2 No.14
-  GL
-  EAC
-  CB scheme
-  CCC
-  ATEX

Marks

-  CE
-  RCM

Order data

Type	Rated control supply voltage	Output contacts	Connection technology	Order code
CM-MSS.11P	24-240 V AC/DC	1 n/o and 1 n/c contact	Push-in terminals	1SVR740720R1400
CM-MSS.11S			Screw terminals	1SVR730720R1400

Connection technology

Maintenance free Easy Connect Technology with push-in terminals

Type designation CM-xxS.yyP

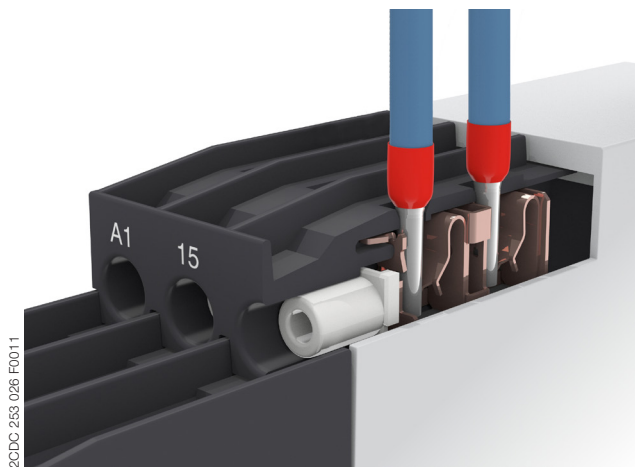

Push-in terminals

- Tool-free connection of rigid and flexible wires with wire end ferrule according to DIN 46228-1-A, DIN 46228-4-E
Wire size: 2 x 0.5-1.5 mm², (2 x 20 - 16 AWG)
- Easy connection of flexible wires without wire end ferrule by opening the terminals
- No retightening necessary
- One operation lever for opening both connection terminals
- For triggering the lever and disconnecting of wires you can use the same tool (Screwdriver according to DIN ISO 2380-1 Form A 0.8 x 4 mm (0.0315 x 0.157 in), DIN ISO 8764-1 PZ1 ø 4.5 mm (0.177 in))
- Constant spring force on terminal point independent of the applied wire type, wire size or ambient conditions (e. g. vibrations or temperature changes)
- Opening for testing the electrical contacting
- Gas-tight

Approved screw connection technology with double-chamber cage connection terminals

Type designation CM-xxS.yyS

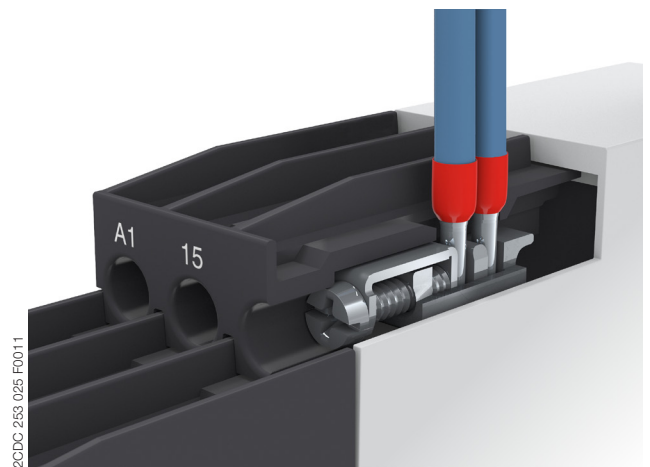

Double-chamber cage connection terminals

- Terminal spaces for different wire sizes:
fine-strand with/without wire end ferrule:
1 x 0.5-2.5 mm² (2 x 20 - 14 AWG),
2 x 0.5-1.5 mm² (2 x 20 - 16 AWG)
rigid:
1 x 0.5-4 mm² (1 x 20 - 12 AWG),
2 x 0.5-2.5 mm² (2 x 20 - 14 AWG)
- One screw for opening and closing of both cages
- Pozidrive screws for pan- or crosshead screwdrivers according to DIN ISO 2380-1 Form A 0.8 x 4 mm (0.0315 x 0.157 in), DIN ISO 8764-1 PZ1 ø 4.5 mm (0.177 in)

Both the Easy Connect Technology with push-in terminals and screw connection technology with double-chamber cage connection terminals have the same connection geometry as well as terminal position.

Functions

Operating controls

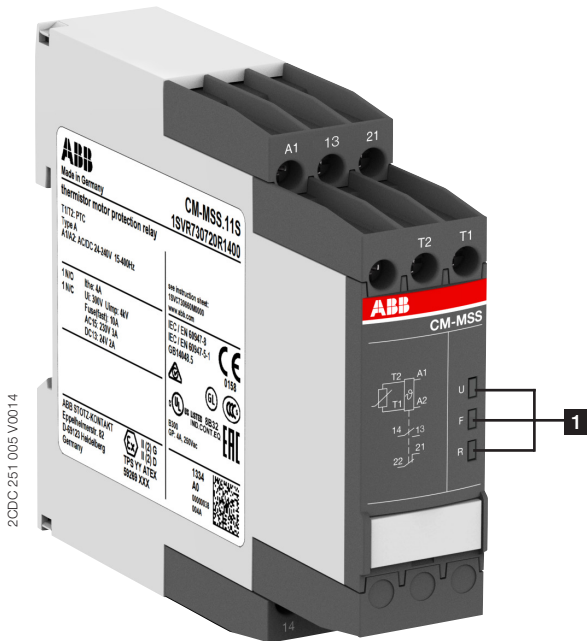

1 Indication of operational states with LEDs

U: green LED - Status indication of control supply voltage
┌───┐
└───┘ Control supply voltage applied

F: red LED - Fault message

R: yellow LED - Status indication of the output relay

Application / Monitoring function

The thermistor motor protection relay CM-MSS monitors the winding temperature and thus protects the motor from overheating, overload and insufficient cooling in accordance to the product standard IEC 60947-8, control units for built-in thermal protection (PTC) for rotating electrical machines.

Operating mode

The thermistor motor protection relay CM-MSS.11 is used to monitor the temperature of motors or generators equipped with PTC resistor sensors type A. The sensors are built-in into the motor windings, measuring the motor heating. In case of an increase of the temperature in the motor, the resistance of the PTC sensors will increase as well. If the motor heats-up excessively ($>2.83 \text{ k}\Omega$) the output relays de-energize and the corresponding LED displays the overtemperature. A reset is only possible after cooling down of the motor ($<1.1 \text{ k}\Omega$) or after a wire interruption within the sensor circuit has been removed.

Dynamic interrupted wire detection

During the operation the device is permanently monitoring the measuring circuit. If the resistance in the measuring circuit rises, the device distinguishes if there is an overtemperature or an interrupted wire. Then the output relays de-energize.

Fault storage, reset function

The fault storage is designed as non-volatile (remanent). Switch-off and return of control supply voltage does not result in a reset of the device. An automatic reset is executed only when the measured value drops below the release threshold.

Electrical connection

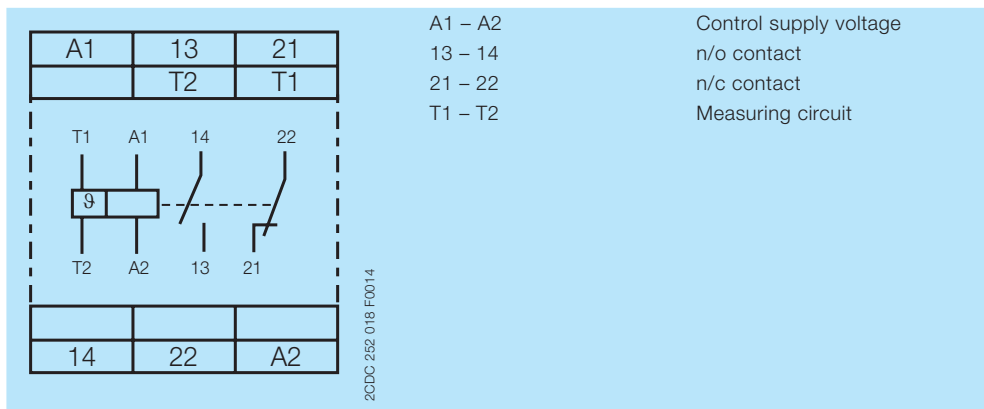

Connection diagram CM-MSS.11

Indication of operational states

LEDs, status information and fault messages

Operational State	U: LED green	F: LED red	R: LED yellow
Absence of control supply voltage	OFF	OFF	OFF
No fault		OFF	
Interrupted wire			OFF
Overtemperature			OFF
Control supply voltage not within the tolerance range			OFF
Internal fault ²⁾	OFF		
Internal fault ²⁾			

¹⁾ Depending on the fault

²⁾ Restart the device. If after restart the same fault is indicated, replace the device

Function diagram

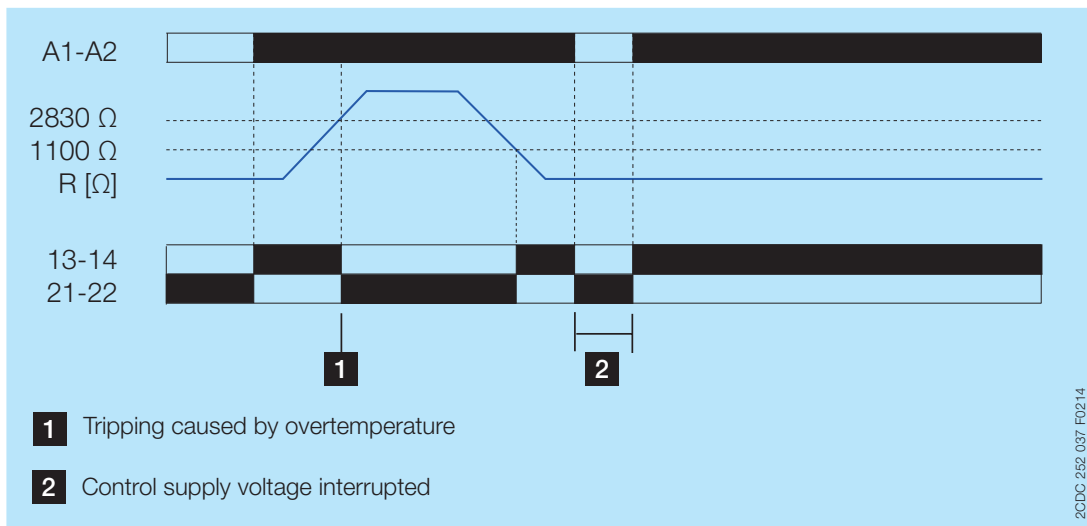

Example of application

Circuit diagram

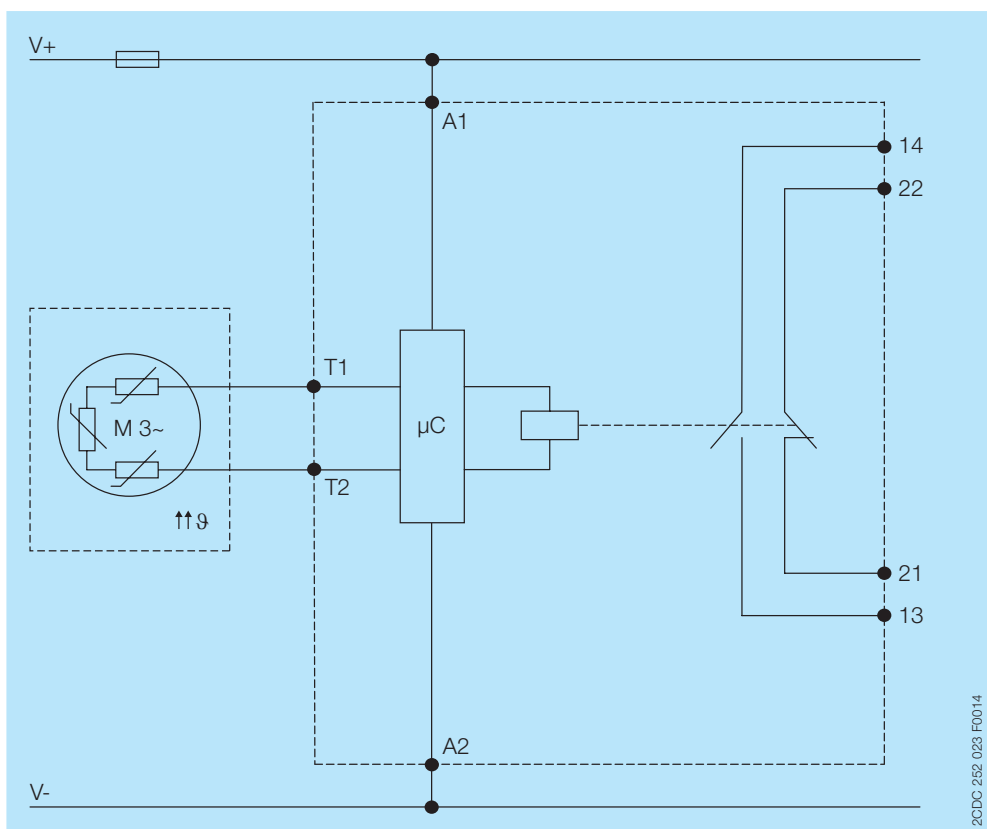

Technical data

Data at $T_a = 25\text{ °C}$ and rated values, unless otherwise indicated

Input circuit

Supply circuit		
Rated control supply voltage U_s	A1-A2	24-240 V AC/DC
Rated control supply voltage U_s tolerance		-15...+10 %
Rated frequency		15-400 Hz
Typical current / power consumption	24 V AC/DC	29 mA / 0.55 VA
	220-240 V AC	11 mA / 1.6 VA
Electrical insulation between supply circuit and measuring circuit		yes
Power failure buffering time		20 ms
Measuring circuit / Sensor circuit		T1-T2
Number of sensor circuits		1
Sensor type		PTC type A (DIN/EN 44081, DIN/EN 44082)
Max. total resistance of sensors connected in series, cold state		< 750 Ω
Overtemperature monitoring	switch-off resistance (relays de-energize)	2.83 k Ω \pm 1 %
	switch-on resistance (relays energize)	1.1 k Ω \pm 1 %
Interrupted wire detection		yes
	switch-off resistance (relays de-energize)	dynamic
	switch-on resistance (relays energize)	not available
Non-volatile fault storage		yes
Maximum voltage in sensor circuit	1.33 k Ω	2.5 V
	4 k Ω	3.7 V
	∞ k Ω	5.5 V
Maximum current in sensor circuit		3.7 mA
Maximum sensor cable length		2 x 100 m at 0.75 mm ² , 2 x 400 m at 2.5 mm ²
Accuracy within the rated control supply voltage tolerance		0.50 %
Accuracy within the temperature range		0.01 %/K
Repeat accuracy (constant parameters)		on request
Reaction time of the safety function		<100 ms
Hardware fault tolerance (HFT)		0
Control circuit		
Control function	auto reset	yes
Maximum no-load voltage		5.5 V
Max. current		0.6 mA
Maximum cable length		2 x 100 m at 0.75 mm ² , 2 x 400 m at 2.5 mm ²

User interface

Indication of operational states		
Control supply voltage	U	LED green
Relay status	R	LED yellow
Fault message	F	See 'LEDs, status information and fault messages' on page 4

Output circuit

Kind of output	13-14	relay, 1 n/o contact
	21-22	relay, 1 n/c contact
Operating principle		closed-circuit principle
Contact material		AgNi alloy, Cd free
Rated operational voltage U_o (IEC/EN 60947-1)		250 V AC
Minimum switching voltage / Minimum switching current		24 V / 10 mA
Maximum switching voltage / Maximum switching current		See 'Load limit curves' on page 10
Rated operating current I_o (IEC/EN 60947-5-1)	AC-12 (resistive) at 230 V	4 A
	AC-15 (inductive) at 230 V	3 A
	DC-12 (resistive) at 24 V	4 A
	DC-13 (inductive) at 24 V	2 A
AC Rating (UL 508)	utilization category (Control Circuit Rating Code)	B 300
	maximum rated operational voltage	250 V AC
	maximum continuous thermal current at B 300	4 A
	maximum making/breaking apparent power at B 300	3600/360 VA
Mechanical lifetime		30 x 10 ⁶ switching cycles
Electrical lifetime	at AC12, 230 V AC, 4 A	0.1 x 10 ⁶ switching cycles
Maximum fuse rating to achieve short-circuit protection	n/c contact	10 A fast-acting
	n/o contact	10 A fast-acting

General data

MTBF		on request	
Duty time		100 %	
Dimensions (W x H x D)	product dimensions	22.5 x 85.6 x 103.7 mm (0.89 x 3.37 x 4.08 in)	
	packaging dimensions	97 x 109 x 30 mm (3.82 x 4.29 x 1.18 in)	
Weight		Screw connection technology	Easy Connect Technology (push-in)
	net weight	0.127 kg	0.119 kg
	gross weight	0.153 kg	0.145 kg
Mounting		DIN rail (IEC/EN 60715), snap-on mounting without any tool	
Mounting position		any	
Minimum distance to other units		10 mm (0.394 in) if switching current > 2 A	
		10 mm (0.394 in) if switching current > 2 A	
Material of housing		UL 94 V-0	
Degree of protection	housing	IP50	
	terminals	IP20	

Electrical connection

		Screw connection technology	Easy Connect Technology (push-in)
Wire size	fine-strand with(out) wire end ferrule	1 x 0.5-2.5 mm ² (1 x 20-14 AWG)	2 x 0.5-1.5 mm ² (2 x 20-16 AWG)
		2 x 0.5-1.5 mm ² (2 x 20-16 AWG)	
	rigid	1 x 0.5-4 mm ² (1 x 20-12 AWG)	2 x 0.5-1.5 mm ² (2 x 20-16 AWG)
		2 x 0.5-2.5 mm ² (2 x 20-14 AWG)	
Stripping length		8 mm (0.32 in)	
Tightening torque		0.6-0.8 Nm (5.31-7.08 lb.in)	-
Wire end ferrule		according to DIN 46228-1-A, DIN 46228-4-E	

Environmental data

Ambient temperature ranges	operation	-25 °C...+60 °C
	storage	-40 °C...+85 °C
Damp heat, cyclic (IEC/EN 60068-2-30)		6 x 24 h cycle, 55 °C, 95 % RH
Climatic category (IEC/EN 60721-3-3)		3K5 (no condensation, no ice formation)
Vibration, sinusoidal (IEC/EN 60255-21-1)		Class 2
Shock (IEC/EN 60255-21-2)		Class 2

Isolation data

Rated insulation voltage U_i (IEC/EN 60947-1, IEC/EN 60664-1)	Supply circuit / Measuring circuit ¹⁾	300 V AC
	Supply circuit / Output circuits	300 V AC
	Measuring circuit ¹⁾ / Output circuits	300 V AC
	Output circuit 1 / Output circuit 2	300 V AC
Rated impulse withstand voltage U_{imp} (IEC/EN 60947-1, IEC/EN 60664-1)	Supply circuit / Measuring circuit ¹⁾	4 kV / 6 kV
	Supply circuit / Output circuits	4 kV / 6 kV
	Measuring circuit ¹⁾ / Output circuits	4 kV / 6 kV
	Output circuit 1 / Output circuit 2	4 kV
Basic insulation (IEC/EN 60664-1)	Supply circuit / Measuring circuit ¹⁾	600 V AC
	Supply circuit / Output circuits	600 V AC
	Measuring circuit ¹⁾ / Output circuits	600 V AC
	Output circuit 1 / Output circuit 2	300 V AC
Test voltage, routine test (IEC/EN 60255-27, IEC/EN 61010-1)	Supply circuit / Measuring circuit ¹⁾	2.5 kV, 50 Hz, 1 min.
	Supply circuit / Output circuits	2.5 kV, 50 Hz, 1 min.
	Measuring circuit ¹⁾ / Output circuits	2.5 kV, 50 Hz, 1 min.
Test voltage, type test (IEC/EN 60255-27)	Supply circuit / Measuring circuit ¹⁾	6 kV / 1.2 - 50 μ s
	Supply circuit / Output circuits	6 kV / 1.2 - 50 μ s
	Measuring circuit ¹⁾ / Output circuits	6 kV / 1.2 - 50 μ s
	Output circuit 1 / Output circuit 2	6 kV / 1.2 - 50 μ s
Protective separation (IEC/EN 61140, IEC/EN 50178)	Supply circuit / Measuring circuit ¹⁾	yes, up to 300 V
	Supply circuit / Output circuits	yes
	Measuring circuit ¹⁾ / Output circuits	yes
	Output circuit 1 / Output circuit 2	no
Pollution degree (IEC/EN 60664-1)		3
Overvoltage category (IEC/EN 60664-1)		III

¹⁾ Potential of measuring circuit = Potential of control circuit

Standards

Product standard	IEC/EN 60255-1; IEC/EN 60947-8
Low Voltage Directive	2006/95/EC
EMC directive	2004/108/EC
ATEX directive	94/9/EC
RoHS directive	2011/65/EC

Electromagnetic compatibility

Interference immunity to		IEC/EN 61000-6-1, IEC/EN 61000-6-2
electrostatic discharge	IEC/EN 61000-4-2	Level 3, 6 kV contact discharge, 8 kV air discharge
radiated, radio-frequency, electromagnetic field	IEC/EN 61000-4-3	Level 3, 10 V/m (1 GHz), 3 V/m (2 GHz), 1 V/m (2.7 GHz)
electrical fast transient / burst	IEC/EN 61000-4-4	Level 3, 2 kV / 5 kHz
surge	IEC/EN 61000-4-5	Level 3, Installation class 3, supply circuit and measuring circuit 1 kV L-L, 2 kV L-N
conducted disturbances, induced by radio-frequency fields	IEC/EN 61000-4-6	Level 3, 0.15-80 MHz, 10 V, 80 % AM (1kHz)
voltage dips, short interruptions and voltage variations	IEC/EN 61000-4-11	Class 3
harmonics and interharmonics	IEC/EN 61000-4-13	Class 3
Additional interference immunity according to product standard EN 60255-1 (reference on EN 60255-26_2011)		
radiated, radio-frequency, electromagnetic field	IEC/EN 61000-4-3	10 V/m (80 MHz - 3 GHz)
conducted disturbances, induced by radio-frequency fields	IEC/EN 61000-4-6	10 V at stated frequencies
damped oscillatory waves	IEC/EN 61000-4-18	Signal lines, symmetric coupling: 1 kV peak voltage Power supply, asymmetric coupling: 2.5 kV peak voltage,
Increased interference immunity acc. to EN 62061 for safety with the evaluation criterion "Fail-Safe" against		IEC/EN 61000-6-1, IEC/EN 61000-6-2
electrostatic discharge	IEC/EN 61000-4-2	Level 3, 6 kV contact discharge, 8 kV air discharge
radiated, radio-frequency, electromagnetic field	IEC/EN 61000-4-3	Level 3, 20 V/m (1 GHz), 6 V/m (2 GHz), 3 V/m (2.7 GHz)
electrical fast transient / burst	IEC/EN 61000-4-4	Level 3, 4 kV / 5 kHz
surge	IEC/EN 61000-4-5	Level 3, Installation class 3, supply circuit and measuring circuit 2 kV L-L, 4 kV L-N
conducted disturbances, induced by radio-frequency fields	IEC/EN 61000-4-6	Level 3, 10 V
voltage dips, short interruptions and voltage variations	IEC/EN 61000-4-11	Class 3
harmonics and interharmonics	IEC/EN 61000-4-13	Class 3
Interference emissions		IEC/EN 61000-6-3, IEC/EN 61000-6-4
high-frequency radiated	IEC/CISPR 22, EN 55022	Class B
high-frequency conducted	IEC/CISPR 22, EN 55022	Class B
high-frequency radiated	Germanischer Lloyd	increased requirements in the emergency call frequency band

Technical diagrams

Load limit curves

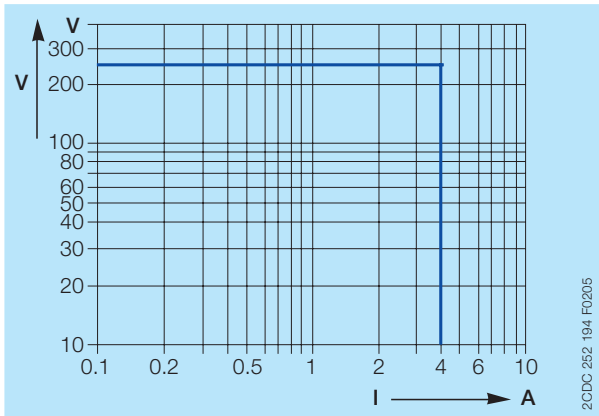

AC load (resistive)

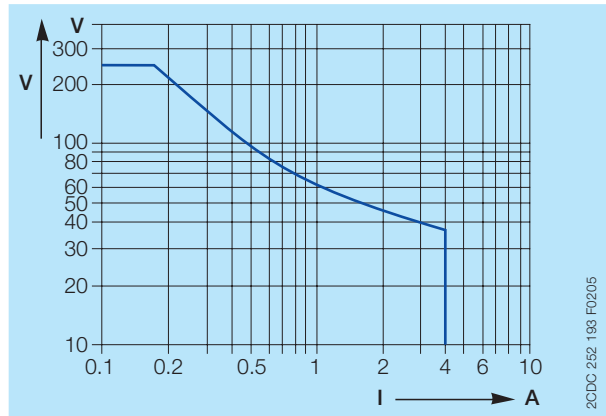

DC load (resistive)

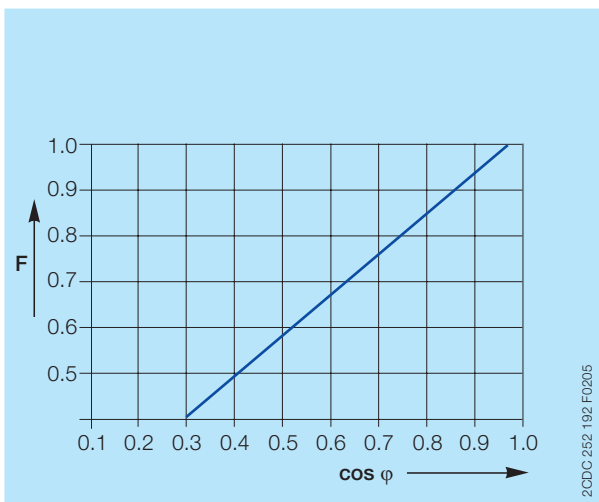

Reduction factor F for inductive AC load

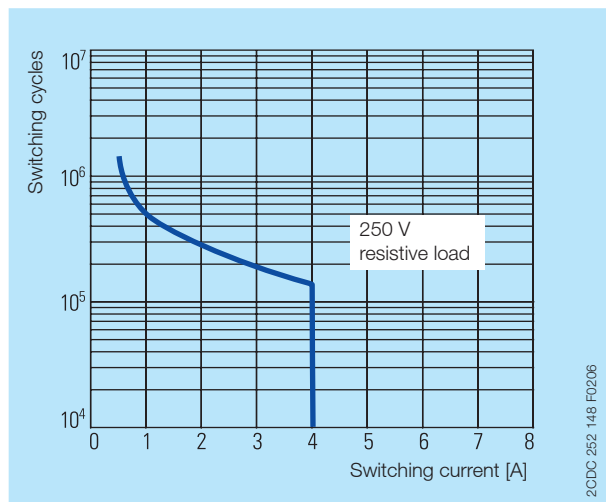

Contact life time / number of operations N
220 V 50 Hz 1 AC, 360 operations/h

Dimensions

in **mm** and inches

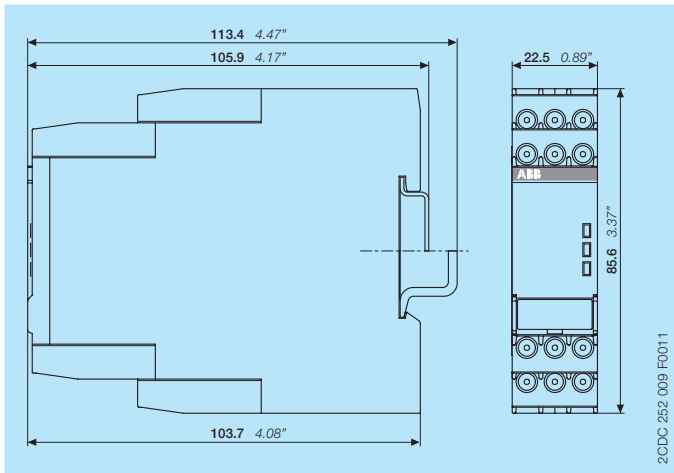

Accessories

in **mm** and inches

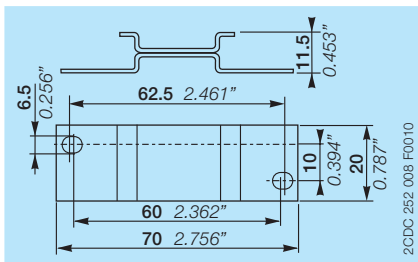

ADP.01 - Adapter for screw mounting

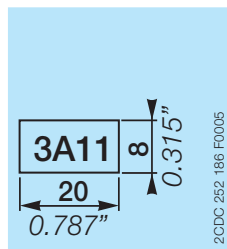

MAR.01 - Marker label for devices without DIP switches

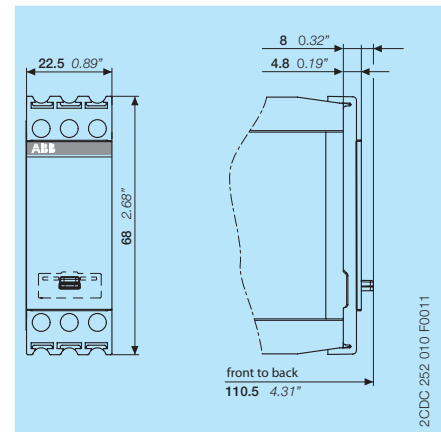

COV.11 - Sealable transparent cover

Further documentation

Document title	Document type	Document number
Electronic products and relays	Technical catalogue	2CDC 110 004 C02xx
Operating and installation instructions CM-MSS.11, CM-MSS.21, CM-MSS.31	Instruction manual	1SVC 730 660 M0000

You can find the documentation on the internet at

<http://new.abb.com/low-voltage/products/epr/monitors/thermistor-motor-protection-relays>

CAD system files

You can find the CAD files for CAD systems at

<http://abb-control-products.partcommunity.com/portal/portal/abb-control-products>

-> Low Voltage Products & Systems -> Control Products -> Electronic Relays and Controls

-> Thermistor Motor Protection Relays.

Contact us

ABB STOTZ-KONTAKT GmbH

P. O. Box 10 16 80
69006 Heidelberg, Germany
Phone: +49 (0) 6221 7 01-0
Fax: +49 (0) 6221 7 01-13 25
E-mail: info.desto@de.abb.com

You can find the address of your
local sales organisation on the
ABB home page
<http://www.abb.com/contacts>
-> Low Voltage Products and Systems

Note:

We reserve the right to make technical changes or modify the contents of this document without prior notice. With regard to purchase orders, the agreed particulars shall prevail. ABB AG does not accept any responsibility whatsoever for potential errors or possible lack of information in this document.

We reserve all rights in this document and in the subject matter and illustrations contained therein. Any reproduction, disclosure to third parties or utilization of its contents – in whole or in parts – is forbidden without prior written consent of ABB AG.

Copyright© 2015 ABB
All rights reserved